



HOME OF EXCELLENCE



Suspension Services Brochure
Lighting | Signage | Audiovisual | Slings | Restrictions



Content

1. LIGHTING
2. SIGNAGE
3. AUDIOVISUAL
4. SLINGS
5. RESTRICTIONS

LIGHTING

Highlight your booth and your products

Our kits are all-inclusive.
Pick up the best package for your space.

All our kits include the slings overhead electrical cables and installation.

Please, keep in mind that the power supply is not included in the kit. The electrical cables will be plugged on the electrical box on the ground, so it has to have the sufficient Kw.



1 Booth from 9 to 24 m²

Overall lighting of your booth

Lighting Kit 1

3 m structure
2 JADE 200W spotlights
Power supply : 1 kW



Lighting Kit 3

6 m structure
4 JADE 200W spotlights
Power supply : 1 kW

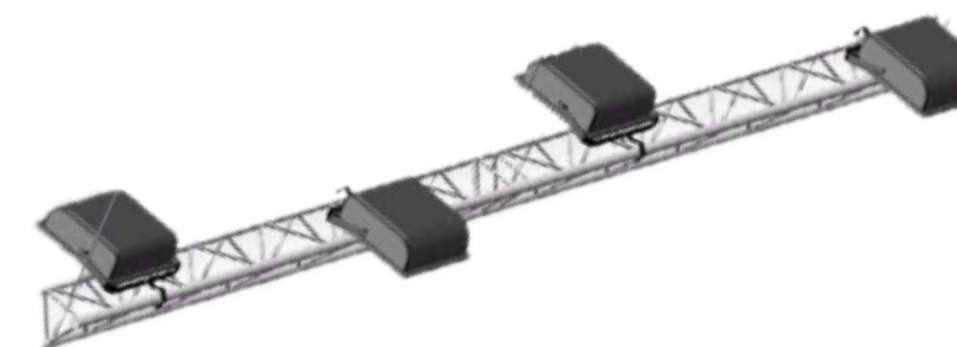

TECHNICAL DETAILS

Two different types of spotlights:

JADE 200W : white, cold light to ensure an homogenous lighting of your whole booth

STUDIO COB 160W : yellow, warm adjustable light for a perfect focus on your products



Focused lighting

Lighting Kit 2

3 m structure
3 Studio Cob 160W spotlights
Power supply : 2 kW

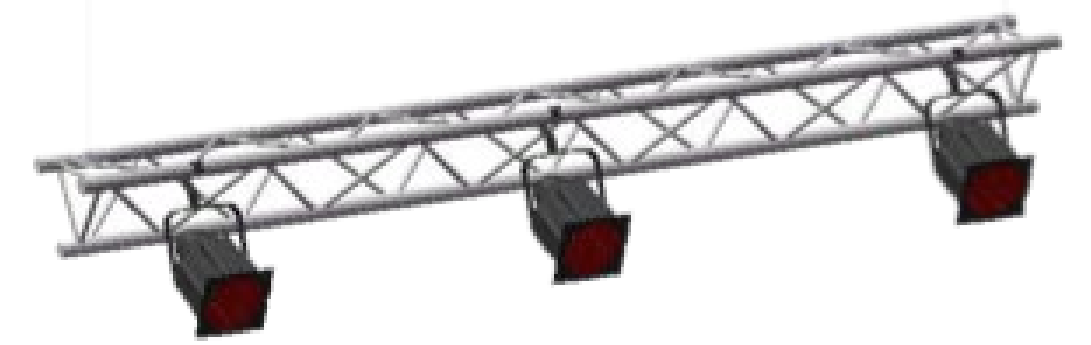

Overall + focused lighting

Lighting Kit 4

6 m structure
3 JADE 200W spotlights
4 Studio Cob 160W spotlights
Power supply : 2 kW

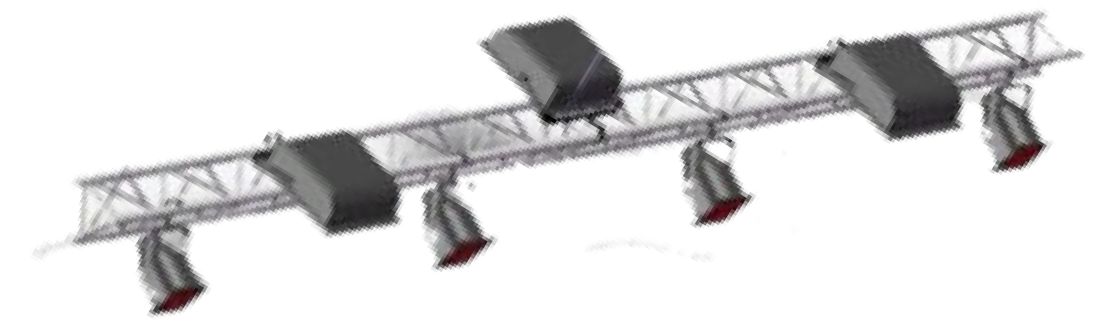

Lighting Kit 5

Structure 3x3 m
4 JADE 200W spotlights
8 Studio Cob 160W spotlights
Power supply : 3 kW

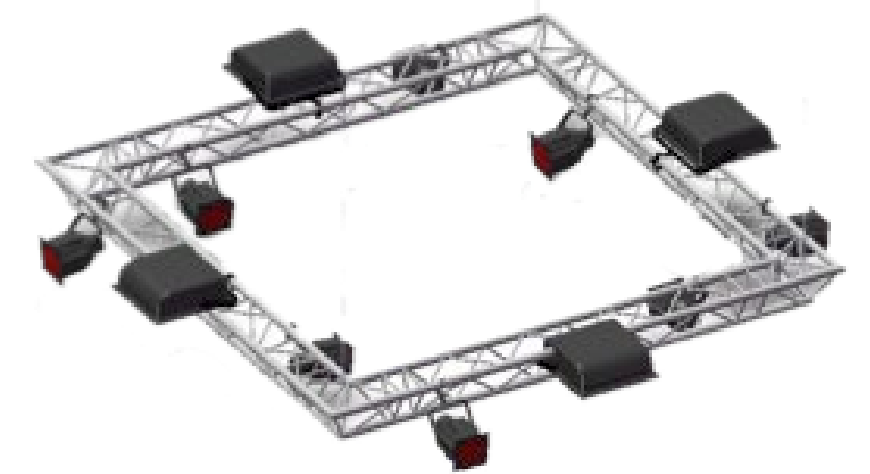

Lighting Kit 6

Structure 2x4 m
4 JADE 200W spotlights
12 Studio Cob 160W spotlights
Power supply : 3 kW

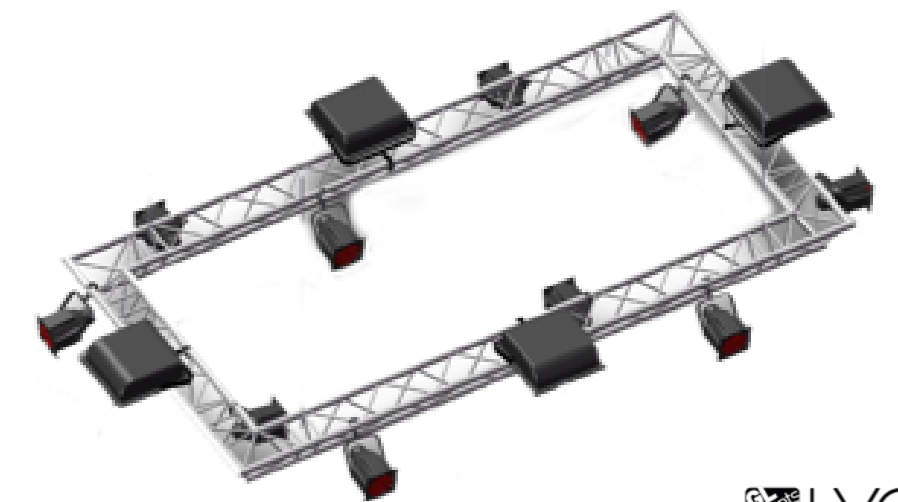



2

Booths 24 m² and more

(All kits provide an overall + focused lighting)



Rectangular Kit

Lighting kit 7

Structure 4x6 m

10 JADE 200W spotlights

14 Studio Cob 160W spotlights

Power supply : 5 kW



Circular Kits

Lighting kit 8

6m diameter structure

5 JADE 200W spotlights

5 Studio Cob 160W spotlights

Power supply : 2 kW

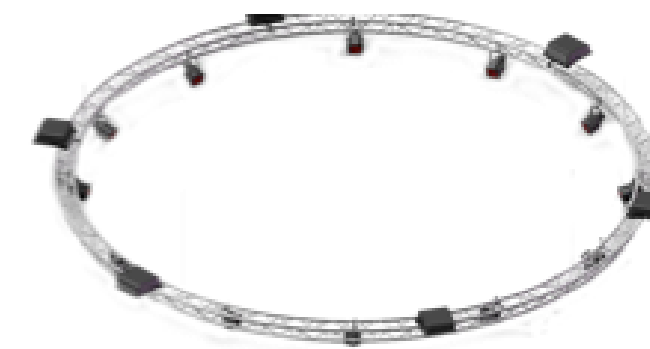

Lighting kit 9

8m diameter structure

6 JADE 200W spotlights

12 Studio Cob 160W spotlights

Power supply : 4 kW

Lighting Kit 10

10m diameter structure

8 JADE 200W spotlights

16 Studio Cob 160W spotlights

Power supply : 4 kW



Semi-Circular Kits

Lighting kit 11

6m diameter structure

5 JADE 200W spotlights

5 Studio Cob 160W spotlights

Power supply : 2 kW



Lighting kit 12

8m diameter structure

6 JADE 200W spotlights

10 Studio Cob 160W spotlights

Power supply : 3 kW

+

Do you need a very precise and personalized kit ?

Don't hesitate to contact us for on-demand kits !



3 Lighting kit with banner

Lighting kit 13 :

Structure 2 x ¼ crown of 6m diameter and 2m of structure
 4 Jade 200W spotlights
 4 StudioCob 160W spotlights
 1 double sided banner 2x1 m
 Power supply : 2 kW

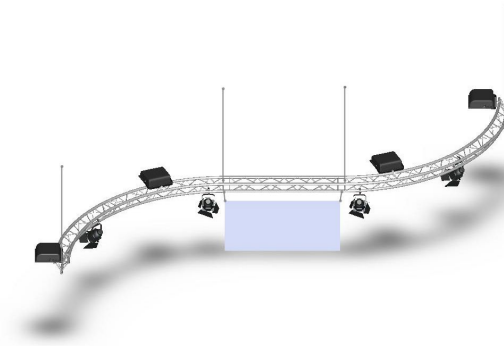

Lighting kit 14 :

Structure 2 x ¼ crown of 8m diameter and 2m of structure
 6 Jade 200W spotlights
 6 StudioCob 160W spotlights
 1 double sided banner 2x1 m
 Power supply : 2,5 kW

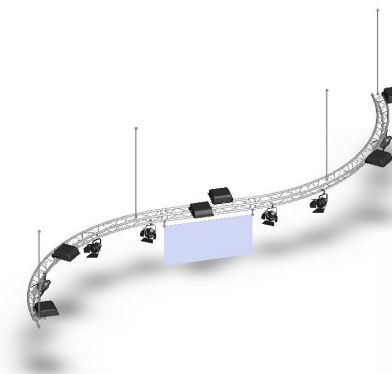

Lighting kit 15 :

Cross-shaped structure of 4,70m
 4 Jade 200W spotlights
 1 square banner 2x1m
 Power supply : 1 kW

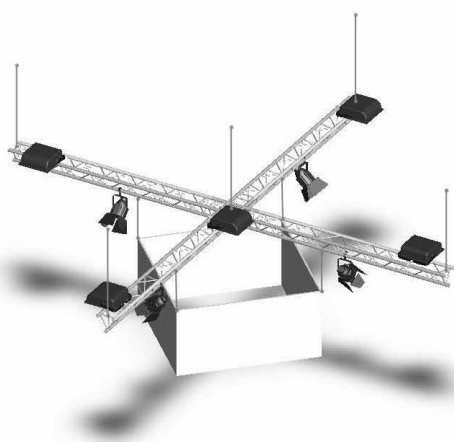
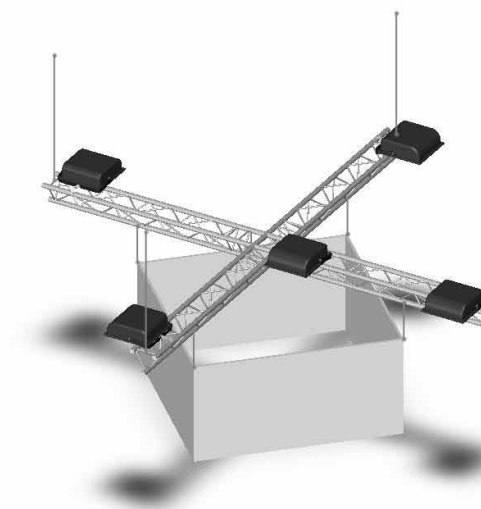

Lighting kit 16 :

Cross-shaped structure of 6,70m
 5 Jade 200W spotlights
 4 StudioCob 160W spotlights
 1 square banner 2x1m
 Power supply : 2 kW

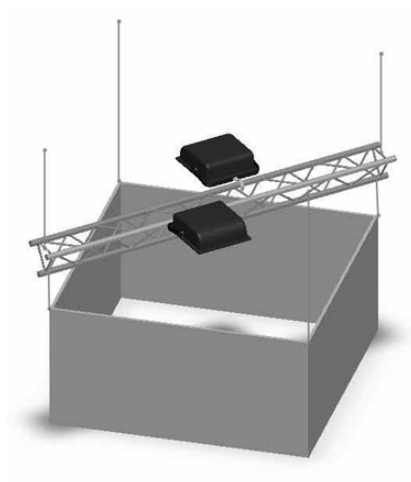

Lighting kit 17 :

3m structure
 2 Jade 200W spotlights
 1 square banner 2x1m
 Power supply : 0,5 kW

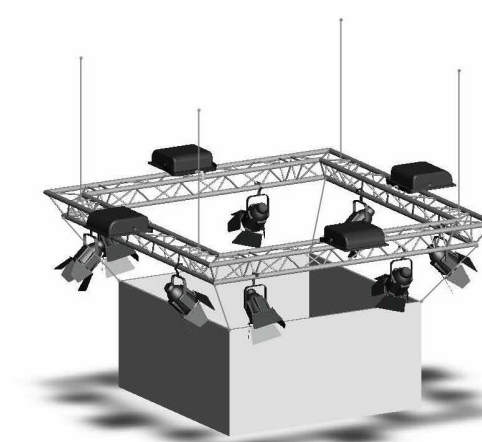

Lighting kit 18 :

Structure 3 x 3m
 4 Jade 200W spotlights
 8 StudioCob 160W spotlights
 1 square banner 2x1m
 Power supply : 2,5 kW

SIGNAGE

Keep a high profile for instant visibility



3 possibilities for overhead suspension: beneath a support truss, support cables or a rotating unit!



Linear module

- 1 m long x 1 m high one side or double-sided
- 2 m long x 1 m high one side or double-sided
- 3 m long x 1 m high one side or double-sided
- 4 m long x 1 m high one side or double-sided



Triangular module*

3 panels 2 m long x 1 m high

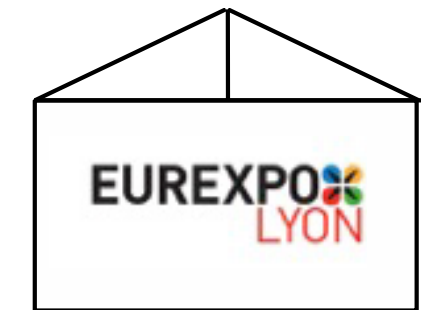

Square module*

4 panels 2 m long x 1 m high



*Single-sided canvas, not recoverable,
Source file must be supplied: vectorised EPS (logo) and high quality JPG (image)
Weight bar and installation included

Rotating kit :

Rotating motor to hang and turn a 4m signage (maxi) (max weight allowed 100kg)

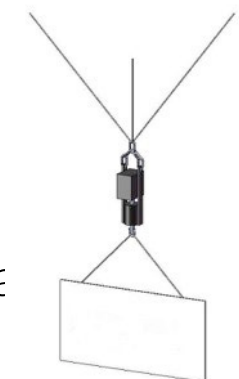

VIDÉO

Bring life to your booth and show your products with dynamism



Wall mounted or suspended screens also available. Prices on demand.

LCD screen : eyecatching!

Feet standing screens on which you can install your peripheral device (DVD player, laptop, USB stick).

Available sizes: (prices for feet standing screens only)

- 43"
- 49"
- 55"

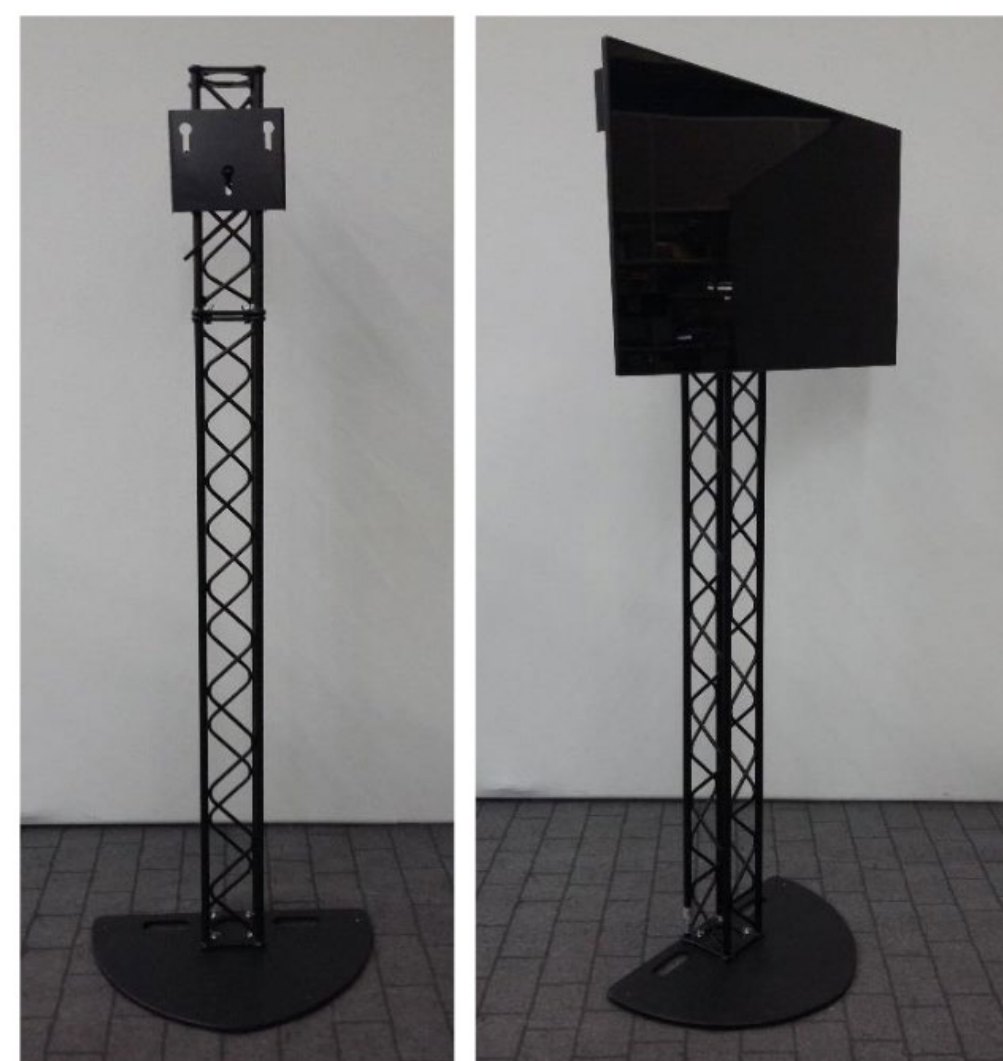

Non-contractual picture

SLINGS

We provide suspension system for you to create your own overhead display



Slings:

Essential for suspending equipment such as lighting truss or signage.

This 6 mm steel cable is attached to one or more framework points using steel shackles and ends in a loop. The number of suspension points depends on the weight and size of the equipment to be suspended.

Power supply on support cables:

A power supply line can be set between the support cables and the switch box on the ground to power the spotlights. Choose the plug you need at the end of the cable.

- 16A (max 3kW)
- 32A P17 tetra-phase

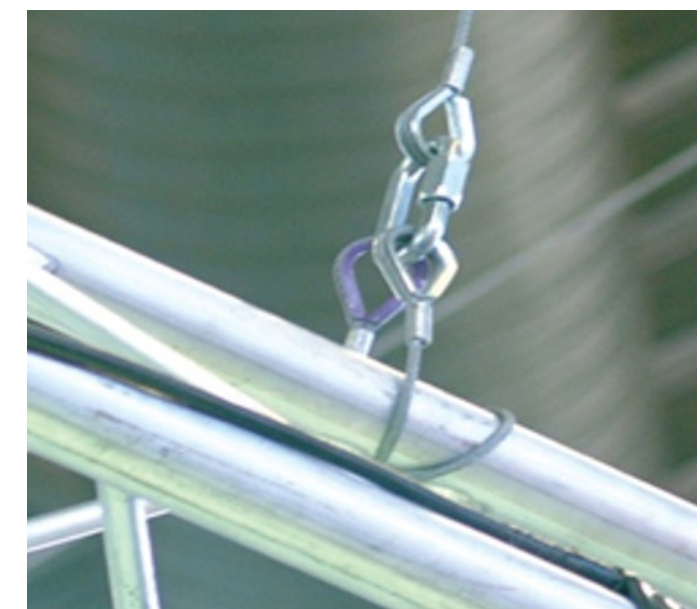

⚠️ RESTRICTIONS

Every project is subject to validation. Its feasibility is not guaranteed.

⚠️ Electrical connection :

- Overhead electrical cables are supplied without being connected to the electric box, if ordered out of a lightning kit or without spotlights.
- Cables supplying more than 3kw come with a P17 socket.

No-rigging zones :

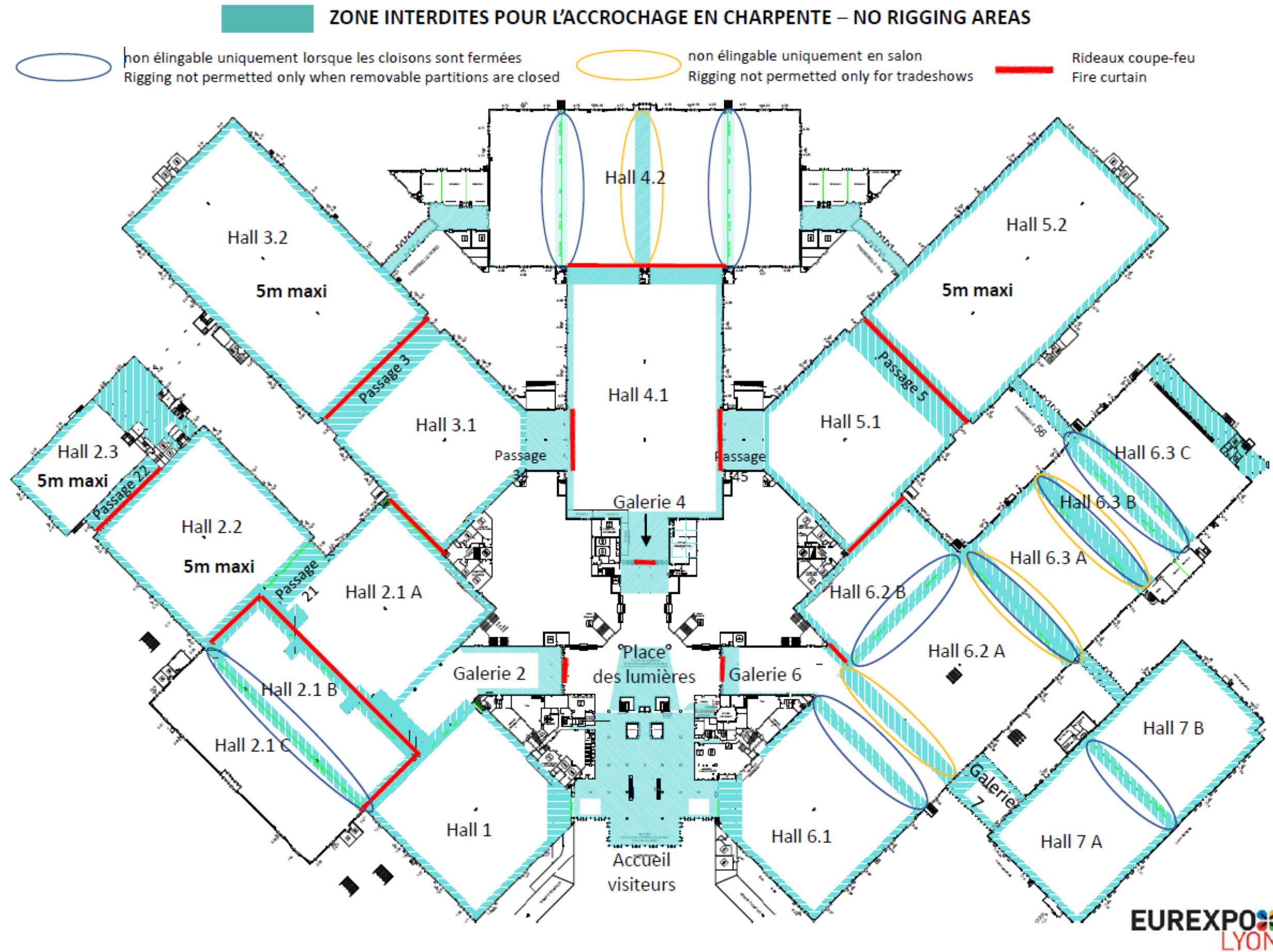

Eurexpo Lyon guaranty:

Installation of the services before your arrival

On-site team with expert knowledge of the exhibition center

Assistance right up to the end of the event



services@eurexpo.com



+33(0)4 72 22 30 30



BP 190 | 69686 Chassieu Cedex | Lyon | France